



*Congratulations on your decision to enjoy the finest Aquatic Fitness System available...
Welcome to the growing family of ENDLESS POOLS owners.*

Pre-Delivery Instructions

Please take the time to read this booklet carefully, as it will provide you with the information you will need to ensure the safe, secure, and timely installation of your system. The following sections are guidelines on how to prepare for delivery and set-up of your new system. Specifically covered are site selection, delivery access, ground preparation, and electrical requirements.

Remember to carefully review the Owner's Manual that accompanies your system, and to register the system's warranty within 10 days of delivery. These items, along with other valuable information, will be found in the Owner's Package which has been placed in the equipment compartment of your system, where you will also find its serial number.

Watkins Manufacturing Corporation reserves the right to change features, specifications and design without notification and without incurring any obligation.

DATE PURCHASED: _____

DATE INSTALLED: _____

DEALER: _____

ADDRESS: _____

TELEPHONE: _____

In most cities and counties, permits will be required for the installation of electrical circuits or the construction of exterior surfaces (decks and gazebos). In addition, some communities have adopted residential barrier codes which may require fencing and/or self-closing gates on the property to prevent unsupervised access to a pool (or spa) by children under 5 years of age. Your **Aquatic Fitness System** may be equipped with a locking cover that meets the ASTM F1346-91 Standard for Safety Covers and as a result, is usually exempt from most barrier requirements. As a general practice, your local Building Department will inform you of any applicable barrier requirements at the time a permit is obtained for the installation of an electrical circuit. Your **ENDLESS POOLS** dealer can provide information on which permits may be required.

Site Selection and Preparation

IMPORTANT: Site selection and preparation are your responsibility. Carefully read these instructions and consult your authorized **ENDLESS POOLS** dealer if you have any questions.

You probably have a spot picked out for your new system, whether it's indoors or outdoors, on a patio or on a deck. Just make sure you check the following:

- Always put your system on a structurally sound, level, and even surface. A filled system can weigh a great deal. Make certain that the location you choose can support the weight of your filled system.
- Locate your equipment compartment, which houses all of the electrical components, in a place where water will drain away from it. Allowing water into the equipment compartment can damage the electronics, or may result in tripping your house's circuit breaker.
- Leave yourself easy access to the circuit breakers in the subpanel.
- Never let water get into the subpanel. Your subpanel is raintight when installed correctly with the door closed.
- Leave access to the equipment compartment for periodic system care and maintenance.

OUTDOOR AND PATIO INSTALLATION

No matter where you install your new system, it's important that you have a solid foundation to support it. Structural damage to the system resulting from incorrect installation or placement on an inadequate foundation is not covered under the system's limited warranty.

If you install the system outdoors, a reinforced concrete pad at least six inches thick is required. The reinforcing rod or mesh in the pad should be attached to a bond wire (see your Owner's Manual). All **Aquatic Fitness System** may be installed onto a deck, provided that the load capacity of the deck is greater than the dead weight of the system (see Deck Installation).

DECK INSTALLATION

To be certain your deck can support your system you must know the deck's maximum load capacity. **Consult a qualified building contractor or structural engineer before you place the system on an elevated deck.** To find the weight of your system, its contents and occupants, refer to the System Specification chart. This weight per square foot must not exceed the structure's rated capacity, or serious structural damage could result.

INDOOR INSTALLATION

Be aware of some special requirements if you place your system indoors. Water will accumulate around the system, so flooring materials must provide a good grip when wet. Proper drainage is essential to prevent a build-up of water around the system. When building a new room for the system, it is recommended that a floor drain be installed. The humidity will naturally increase with the system installed. Water may get into woodwork and produce dryrot, mildew, or other problems. Check for airborne moisture's effects on exposed wood, paper, etc. in the room. To minimize these effects, it is best to provide plenty of ventilation to the system area. Installation of a dehumidifier or exhaust fan in conjunction with an **Aquatic Fitness System** is recommended. An architect can help to determine if more ventilation must be installed.

Your **ENDLESS POOLS** dealer can help you with local information such as zoning regulations and building codes.

RECESSED INSTALLATION

If you plan to recess your new Endless Pools Fitness system in a deck, patio, or other hardscape element, there are a few items to consider during the preparation process. Like other installations, it is important to have a solid foundation that will support the Fitness System. It is also important to check the blueprints of your property to ensure no underground power cables, phone lines, or water pipes will be affected by the recessed installation. We recommend there be at least 36" of crawl space access outside of your Fitness System equipment compartment for maintenance. In addition, we recommend at least 24" of clearance around the perimeter of the Fitness System. This can be in the form of a crawl space. Don't forget to define the location of the subpanel, a minimum of 5 feet a way from the Fitness System. Finally, it is important to install your Fitness System in a way that will protect it from rising water levels. Keep in mind, recessed installations can be susceptible to flooding and should have adequate drainage. A contractor or architect should be able to make specific recommendations on proper drainage as well as the other items to consider above.

DELIVERY ACCESS

It may be necessary to remove a gate, part of a fence, or other movable obstructions in order to move the system to its installation site. Your system will determine what equipment is necessary to move your system to its final location. A roll back truck with a tilt bed is a good option if your site can be accessed by an across road vehicle. When a small reach is needed for the final placement of your system, a boom truck is ideal. A telehandler vehicle can off load, traverse property and place your system in a more challenging situation or terrain. When access to your site is limited a crane may be used to lift your system over obstructions for precise placement.

The **ENDLESS POOLS** delivery personnel will supervise the crane delivery and complete the system installation. **NOTE:** If your system delivery requires the use of a crane, you may be required to pay for its services at the completion of the delivery.

<i>Model</i>	<i>Width W</i>	<i>Length L</i>	<i>Height H</i>
X200/R200/R500	7'5"	12'0"	50"
X500	7'5"	15'0"	50"
E500-52	7'5"	15'0"	52"
E500-58	7'5"	15'0"	58"
E500-58 TREADMILL	7'5"	15'0"	58"
E550-58	7'10"	15'0"	58"
E550-58 TREADMILL	7'10"	15'0"	58"
E700-52	7'5"	17'0"	52"
E700-58	7'5"	17'0"	58"
E700-58 TREADMILL	7'5"	17'0"	58"
E2000/X2000 E2000 TREADMILL	7'5"	20'0"	58"

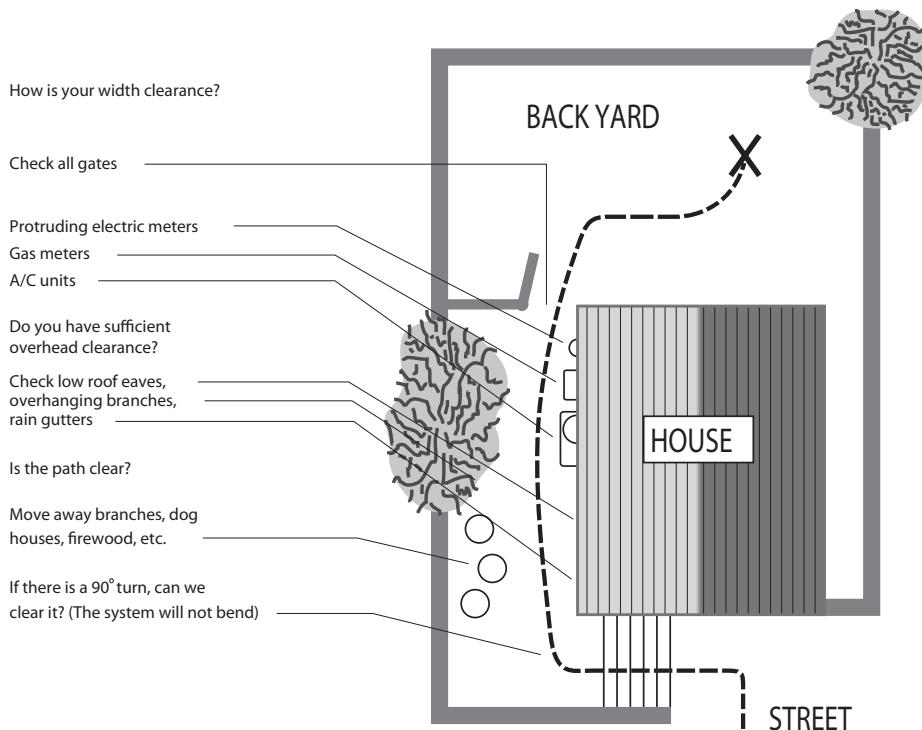

GROUND PREPARATION

A reinforced concrete pad at least six inches thick or a deck that is able to withstand more than 250 lbs. per square foot is required for the **Aquatic Fitness System**. As a homeowner, it is your responsibility to provide a suitable, level foundation for your system. Keep in mind that most delivery crews are not equipped to level and prepare system sites.

If you are interested in having a concrete slab, your **ENDLESS POOLS** dealer should be able to suggest a qualified, licensed contractor.

NOTE: In order for the system to operate properly and the internal plumbing to drain completely, you must ensure that the system is level.

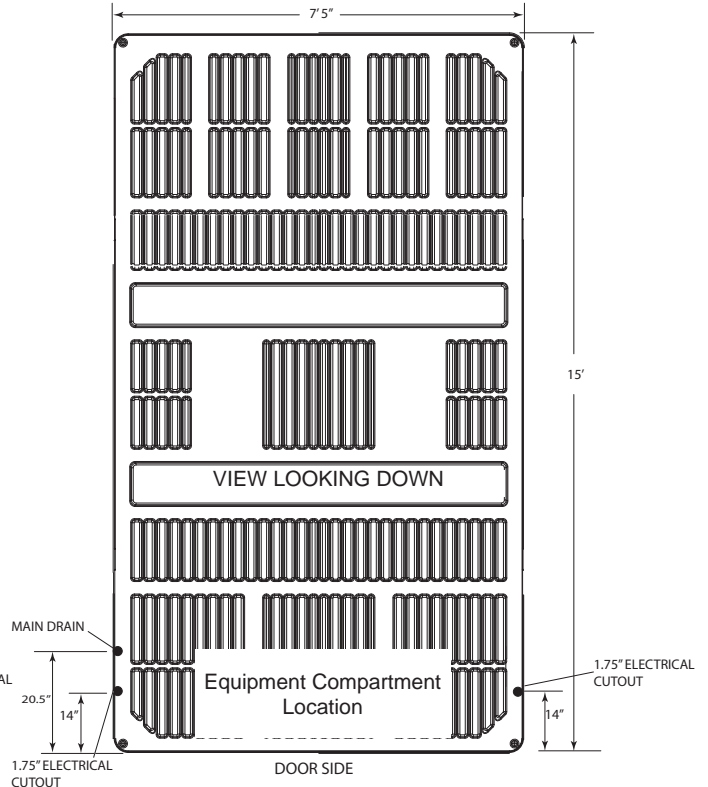
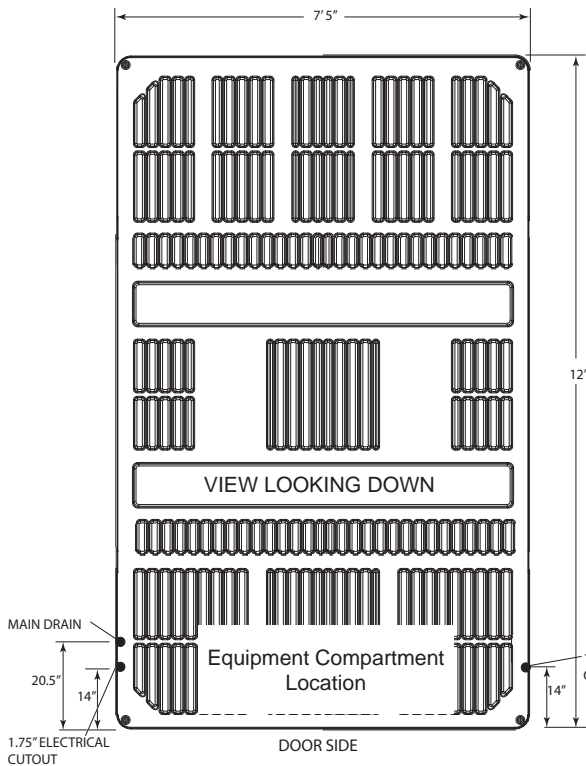
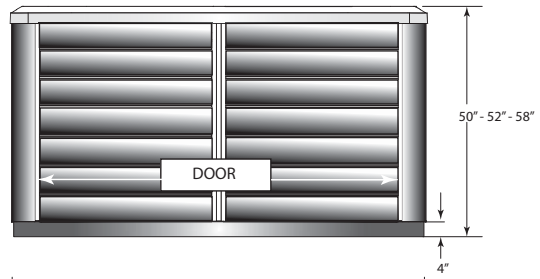
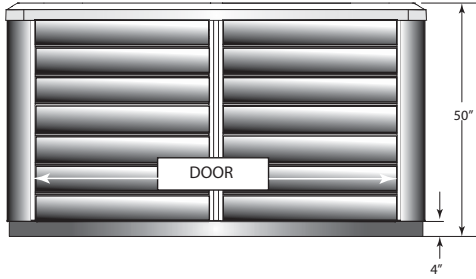

X200
R200
R500

E500-52
E500-58
E500-58 Treadmill
X500-50

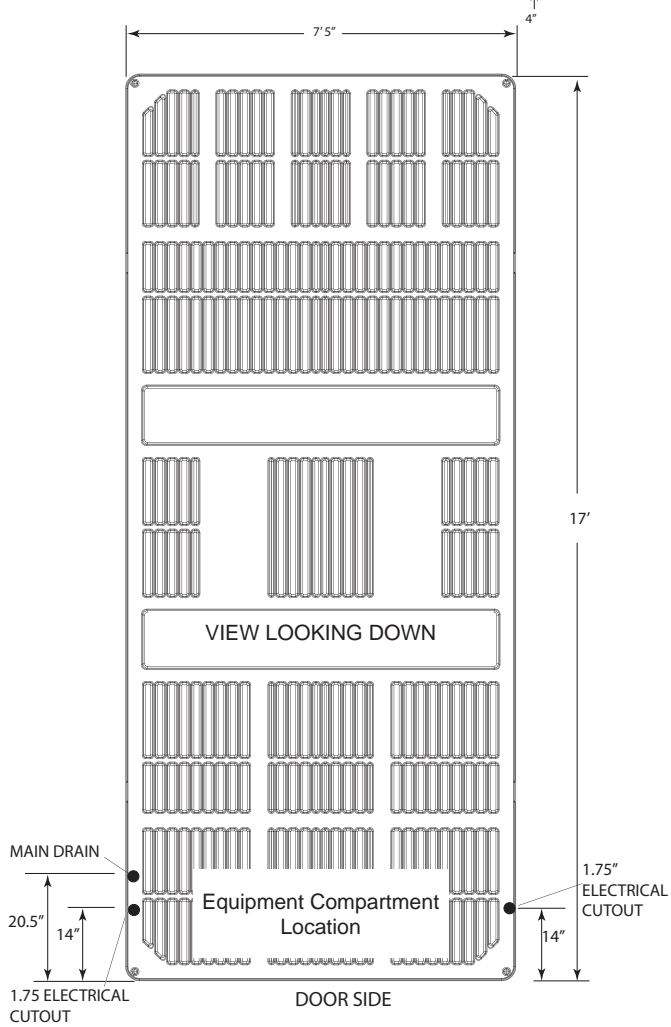
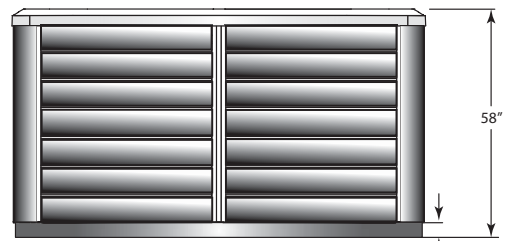
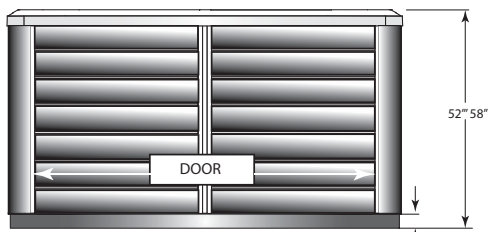

E700-52
 E700-58
 E700-58 Treadmill

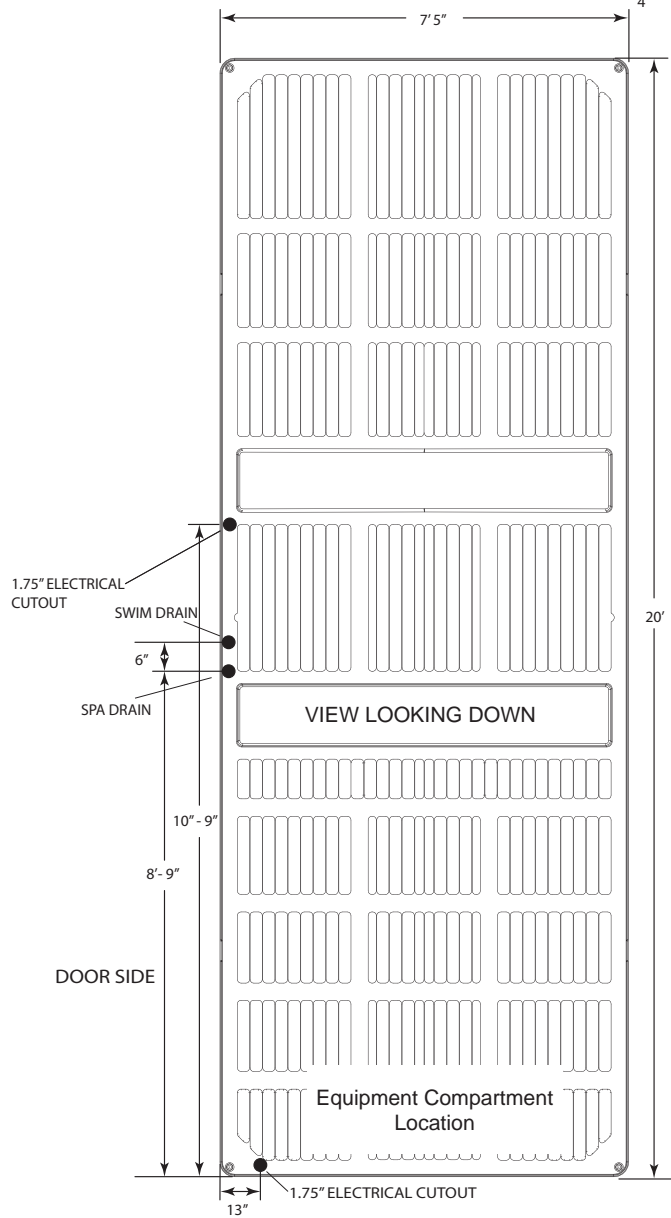

E2000
 E2000 Treadmill
 X2000

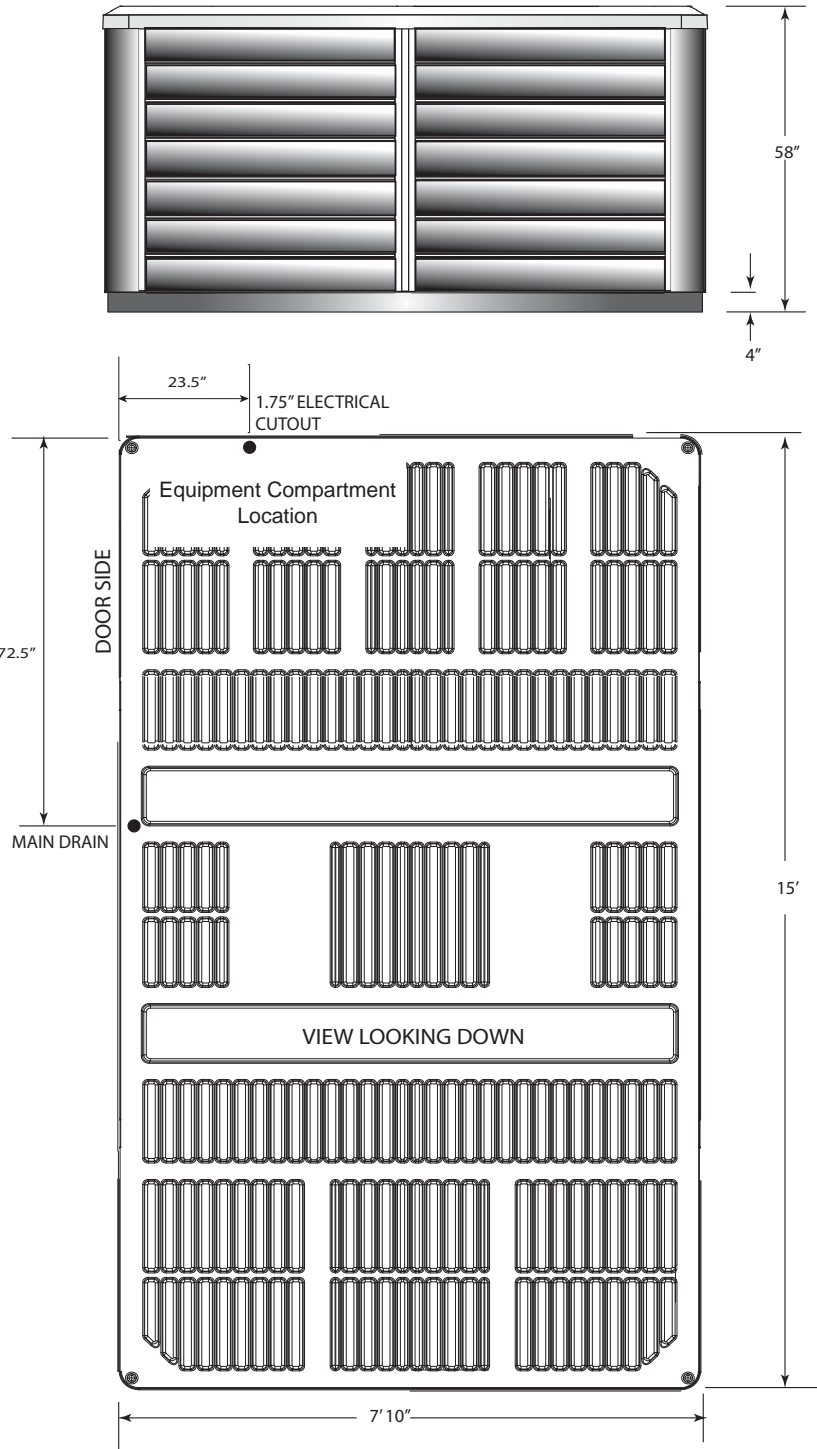

E550-58
E550-58 Treadmill

ELECTRICAL REQUIREMENTS

To ensure you will have an opportunity to use your system soon after delivery, it is very important that the required electrical service has been installed. Unless otherwise stipulated by your dealer, THIS IS YOUR RESPONSIBILITY.

IMPORTANT: All electrical circuits must be installed by a qualified, licensed electrician.

All X and E models require a 60 amp, single phase, 230 volt circuit breaker, R model require a 30 amp 230 volt breaker in the main electrical service panel.

All **Aquatic Fitness System** must be wired in accordance with applicable local and national electrical codes, all electrical work must be done by a licensed electrician.

NOTE: Watkins Manufacturing Corporation REQUIRES THE USE OF A SUBPANEL TO SUPPLY POWER AND PROTECT THE SYSTEM. A licensed electrician should install a four-wire electrical service (two line voltages, one neutral, one ground) from the main electrical service panel to the subpanel, and from the sub-panel to the system per the appropriate wiring diagram as illustrated below.

The grounding conductor must be at least #6 AWG. Your electrician should mount the subpanel in the vicinity of the system but it should not be closer than five (5) feet from the system water edge (NEC 680-38 to 41-A-3).

INSTALLATION NOTE: After the system has been installed by the dealer's delivery crew, your electrician can connect the conduit from the subpanel to the **Aquatic Fitness System** Control Box and then complete the wiring connections in the control box.

NOTE: Complete step-by-step Installation and Wiring Instructions for all 230 volt **ENDLESS POOLS** models are included in the Owner's Manual and with each sub-panel, which can be obtained from your dealer.

WARNING: Removing or bypassing the GFCI breakers in the subpanel at any time will result in an unsafe system and will void the warranty.

WIRE SPECIFICATION NOTE: Long electrical runs may require a larger gauge feed wire than stated. We recommend that a maximum voltage drop of 3% be used when calculating the larger wire size.

Refer to the Wiring Diagrams below for the electrical requirements this model.

When connecting the supply conduit, use a liquid-tight flex conduit fitting.

X200, X500

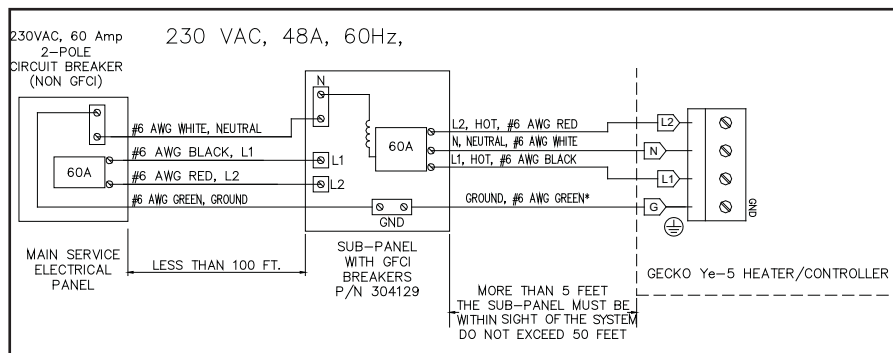

E500-52, E500-58, E500-58 Treadmill, E700-52, E700-58, E700-58 Treadmill

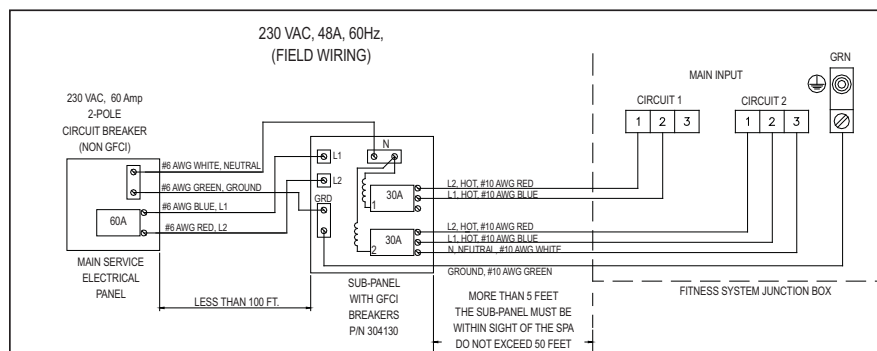

ELECTRICAL REQUIREMENTS

E2000, E2000 Treadmill, E550-58, E550-58 Treadmill

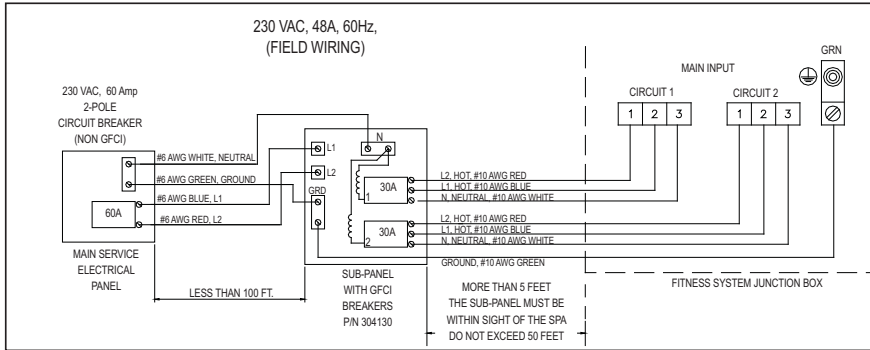

X2000

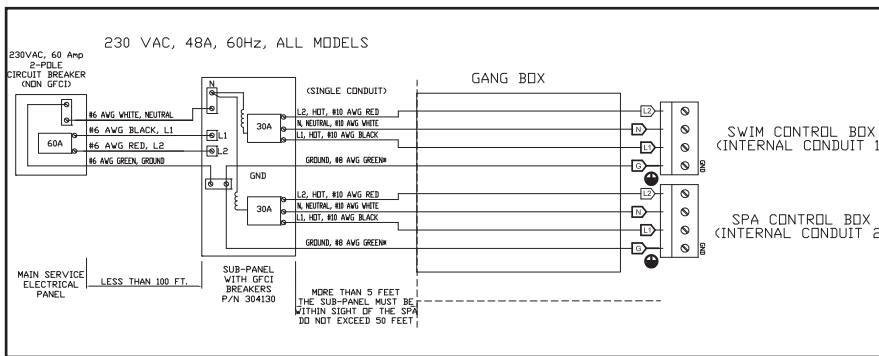

R200/R500

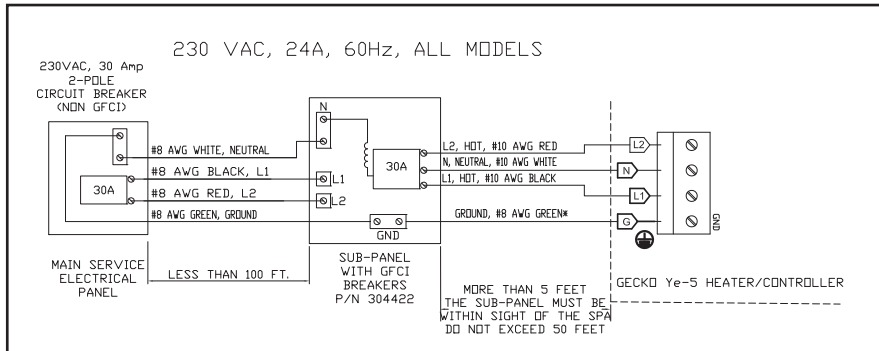

System Specifications

	Footprint Dimensions	Height	Effective Filter Area	Heater (Watts)	Water Capacity	Dry Weight	Filled Weight	Dead Weight*	Electrical Requirements
X200	12' 0" x 7'5"	50"	100 Square Feet	4,000	1,210 gallons	2,255 lbs.	14,100 lbs	185 lbs. per square foot	230 volt, 60 amp single phase GFCI protected circuit
X500	15' 0" x 7'5"	50"	200 Square Feet	4,000	1,650 gallons	2,705 lbs.	18,200 lbs	190 lbs. per square foot	230 volt, 60 amp single phase GFCI protected circuit
X2000	20'0" x 7"5"	58"	200 Square Feet 50 Square Feet (Spa)	4,000	Swim 2,000 gallons Spa 350 gallons	4.095 lbs.	24,810 lbs	250 lbs. per square foot	230 volt, 60 amp single phase GFCI protected circuit
E500-52	15' 0" x 7'5"	52"	200 Square Feet	4,000	1,635 gallons	3,200 lbs.	18,200 lbs	190 lbs. per square foot	230 volt, 60 amp single phase GFCI protected circuit
E500-58	15'0" x 7"5"	58"	200 Square Feet	4,000	1,770 gallons	3,400 lbs.	19,195 lbs	205 lbs. per square foot	230 volt, 60 amp single phase GFCI protected circuit
E500-58 Treadmill	15'0" x 7"5"	58"	200 Square Feet	4,000	1,735 gallons	3,500 lbs.	19,720 lbs	205 lbs. per square foot	230 volt, 60 amp single phase GFCI protected circuit
E550-58	15'0" x 7"10"	58"	200 Square Feet	4,000	2,392 gallons	3,575 lbs	25,258 lbs	245 lbs. per square foot	230 volt, 60 amp single phase GFCI protected circuit
E550-58 Treadmill	15'0" x 7"10"	58"	200 Square Feet	4,000	2,360 gallons	3,680 lbs	25,112 lbs	245 lbs. per square foot	230 volt, 60 amp single phase GFCI protected circuit
E700-52	17'0" x 7"5"	52"	200 Square Feet	4,000	1,975 gallons	2,980 lbs.	21,205 lbs	195 lbs. per square foot	230 volt, 60 amp single phase GFCI protected circuit
E700-58	17'0" x 7"5"	58"	200 Square Feet	4,000	2,150 gallons	3,025 lbs.	22,710 lbs	210 lbs. per square foot	230 volt, 60 amp single phase GFCI protected circuit
E700-58 Treadmill	17'0" x 7"5"	58"	200 Square Feet	4,000	2,100 gallons	3,480 lbs.	22,745 lbs	210 lbs. per square foot	230 volt, 60 amp single phase GFCI protected circuit
E2000-58	20'0" x 7"5"	58"	200 Square Feet 50 Square Feet (Spa)	4,000	Swim 2,045 gallons Spa 290 gallons	4,090 lbs.	25,815 lbs	200 lbs. per square foot	230 volt, 60 amp single phase GFCI protected circuit
E2000-58 Treadmill	20'0" x 7"5"	58"	200 Square Feet	4,000	Swim 2,000 gallons Spa 350 gallons	4.095 lbs.	25,545 lbs	200 lbs. per square foot	230 volt, 60 amp single phase GFCI protected circuit
R200	12' 0" x 7'5"	50"	100 Square Feet	4,000	1,335 gallons	1,845 lbs	14,730 lbs	190 lbs. per square foot	230 volt, 30 amp single phase GFCI protected circuit
R500	12' 0" x 7'5"	50"	100 Square Feet	4,000	1,785 gallons	2,055 lbs	18,690 lbs	195 lbs. per square foot	230 volt, 30 amp single phase GFCI protected circuit

CAUTION: Watkins Manufacturing Corporation suggests a structural engineer or contractor be consulted before the system is placed on an elevated deck.

* **NOTE:** The "Filled weight" and "Dead weight" of the system includes the weight of the occupants (assuming an average occupant weight of 175 lbs).

**SERVICES AVAILABLE FROM YOUR
ENDLESS POOL DEALER**

Service	Cost
Pre-Delivery site inspection	_____
Deliver system to installation site	_____
Unwrap system and haul away packaging material	_____
Set up & level system	_____
Fill the system with water	_____
Connect the system to its power source	_____
Explain and test the system's operation	_____
<ul style="list-style-type: none"> • Jet system • Set temperature control 	_____
<ul style="list-style-type: none"> • Control panel functions 	_____
Explain the safety features	_____
<ul style="list-style-type: none"> • GFCI • Heater thermal cut-off 	_____
<ul style="list-style-type: none"> • Heater high limit 	_____
General system operation & maintenance orientation	_____
Water quality and maintenance orientation	_____
Adjust the water's Total Alkalinity, Calcium Hardness and pH	_____
Sanitize the water	_____
Inspect the system cover, place on system	_____
Review winterizing instructions	_____
Review Owner's Manual & Warranty Card	_____
Follow-up call	_____
In-store system water analysis	_____
	TOTAL
COST	_____

CONTRACTOR SUGGESTIONS

Electrician

Name: _____

Telephone: _____

Name: _____

Telephone: _____

Masonry

Name: _____

Telephone: _____

Name: _____

Telephone: _____

General

Name: _____

Telephone: _____

Name: _____

Telephone: _____



Watkins Wellness™

Feel good. Live well.™

WATKINS MANUFACTURING CORPORATION

1280 Park Center Drive

Vista, California 92081

(800) 999-4688 extension 8432

©2016 Watkins Manufacturing Corporation. SWIMCROSS is a trademark of Watkins Manufacturing Corporation

Part #63084 Rev.N (1/19)