



HotSpring®

Every day made better®

LIMELIGHT® Collection

Congratulations on your decision to enjoy the finest spa available...

Welcome to the growing family of Hot Spring spa owners.

Pre-Delivery Instructions

Please take the time to read this booklet carefully, as it will provide you with the information you will need to ensure the safe, secure, and timely installation of your new spa. The following sections are guidelines on how to prepare for delivery and set-up of your new spa. Specifically covered are site selection, delivery access, ground preparation, and electrical requirements.

Remember to carefully read the Owner's Manual that accompanies your spa, and to complete the Warranty Card within 10 days of delivery. These items, along with other valuable information, will be found in the Owner's Package which has been placed in the equipment compartment of your spa, where you will also find its serial number.

Watkins Wellness™ reserves the right to change features, specifications and design without notification and without incurring any obligation.

DATE PURCHASED: _____

DATE INSTALLED: _____

DEALER: _____

ADDRESS: _____

TELEPHONE: _____

Register your warranty
using the QR code below:



In most cities and counties, permits will be required for the installation of electrical circuits or the construction of exterior surfaces (decks and gazebos). In addition, some communities have adopted residential barrier codes which may require fencing and/or self-closing gates on the property to prevent unsupervised access to a pool (or spa) by children under 5 years of age. Your Hot Spring spa is equipped with a locking cover that meets the ASTM F1346 Standard for Safety Covers and as a result, is usually exempt from most barrier requirements. As a general practice, your local Building Department will inform you of any applicable barrier requirements at the time a permit is obtained for the installation of an electrical circuit. Your Hot Spring dealer can provide information on which permits may be required.

Site Selection and Preparation

IMPORTANT: Site selection and preparation are your responsibility. Carefully read these instructions and consult your authorized Hot Spring® dealer if you have any questions.

You probably have a spot picked out for your new spa, whether it's indoors or outdoors, on a patio or on a deck. Just make sure you check the following:

- Always put your spa on a structurally sound, level surface. A filled spa can weigh a great deal. Make certain that the location you choose can support the weight of your filled spa.
- Locate your spa away from any reflective surface or glass. The heat generated by some types of double-pane windows and reflective surfaces can cause serious damage to the exterior of the spa, including the siding and cover.
- Locate your equipment compartment, which houses all of the electrical components, in a place where water will drain away from it. Allowing water into the equipment compartment can damage the electronics, or may result in tripping your house's circuit breaker.
- Leave yourself easy access to the circuit breakers in the subpanel.
- Never let water get into the subpanel. Your spa's subpanel is rain tight when installed correctly with the door closed.
- Leave access to the equipment compartment for periodic spa care and maintenance.

OUTDOOR AND PATIO INSTALLATION

No matter where you install your new spa, it's important that you have a solid foundation to support it. Structural damage to the spa resulting from incorrect installation or placement on an inadequate foundation is not covered under the spa's limited warranty.

If you install the spa outdoors, a reinforced concrete pad at least four inches thick is recommended. The reinforcing rod or mesh in the pad should be attached to a bond wire (see your Owner's Manual). All Hot Spring spas may be installed onto a deck, provided that the load capacity of the deck is greater than the dead weight of the spa (see Deck Installation).

DECK INSTALLATION

To be certain your deck can support your spa, you must know the deck's maximum load capacity. **Consult a qualified building contractor or structural engineer before you place the spa on an elevated deck or indoors.** To find the weight of your spa, its contents and occupants, refer to the Spa Specification chart located further into these instructions. This weight per square foot must not exceed the structure's rated capacity, or serious structural damage could result.

INDOOR INSTALLATION

Be aware of some special requirements if you place your spa indoors. Water will accumulate around the spa, so flooring materials must provide a good grip when wet. Proper drainage is essential to prevent a build-up of water around the spa. When building a new room for the spa, it is recommended that a floor drain be installed. The humidity will naturally increase with the spa installed. Water may get into woodwork and produce dry rot, mildew, or other problems. Check for airborne moisture's effects on exposed wood, paper, etc. in the room. To minimize these effects, it is best to provide plenty of ventilation to the spa area. An architect can help to determine if more ventilation must be installed.

Your Hot Spring dealer can help you with local information such as zoning regulations and building codes.

DELIVERY ACCESS

First, locate the dimensions of your spa on the following chart. The dimensions shown are the measurements of the spa in the vertical position, laid on its side.

Next, contact your dealer to find the height and width added by the delivery cart which the dealer will use to deliver your new spa. Use the height of the cart plus the dimension shown as H to determine the vertical clearance required to pass the spa and cart. Use the width of the cart, or dimension W, whichever is greater, to determine the maximum width of clearance necessary. Use the length dimension L when making any sharp turns to determine the maximum clearance required.

NOTE: It may be necessary to allow for additional over-head clearance if the spa (with cart) will be pushed up or down an incline or moved up or down a short flight of stairs.

Use the information below to determine the requirements for access to your desired location.

It may be necessary to remove a gate, part of a fence, or other movable obstructions in order to roll the spa to its installation site. About ten percent of the time, a crane is the only way to install the spa by lifting it to its final destination.

If the spa has to be taken off of the cart to go over a wall (either because the entry area is too narrow, the eaves are too low, the corner is too tight, or the stairway is too steep), a crane will be required. Don't be alarmed!

The crane has a truck-mounted boom which can fit right in your driveway. Crane operators are licensed and insured. For a charge, the crane operator will lift your spa over walls, buildings, or any other obstruction and place it as close to the installation site as possible. The Hot Spring® spa delivery personnel will supervise the crane delivery and complete the spa installation.

NOTE: If your spa delivery requires the use of a crane, you may be required to pay for its services at the completion of the delivery.

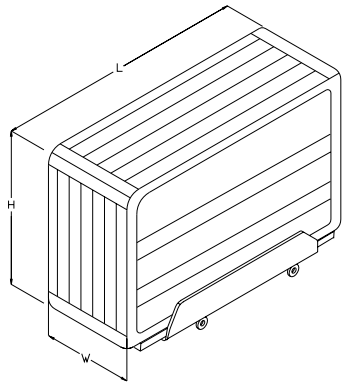

Model	Width W	Length L	Height H
Prism™ (PSM)	38" (97 cm)	110" (2.79 m)	91" (2.31 m)
Pulse® (PLS)	38" (97 cm)	89" (2.26 m)	89" (2.26 m)
Flair® (FLR)	36" (91 cm)	84" (2.13 m)	84" (2.13 m)
Flash™ (FSH)	36" (91 cm)	84" (2.13 m)	84" (2.13 m)
Beam™ (BMI & BMII)	33" (84 cm)	80" (2.03 m)	80" (2.03 m)

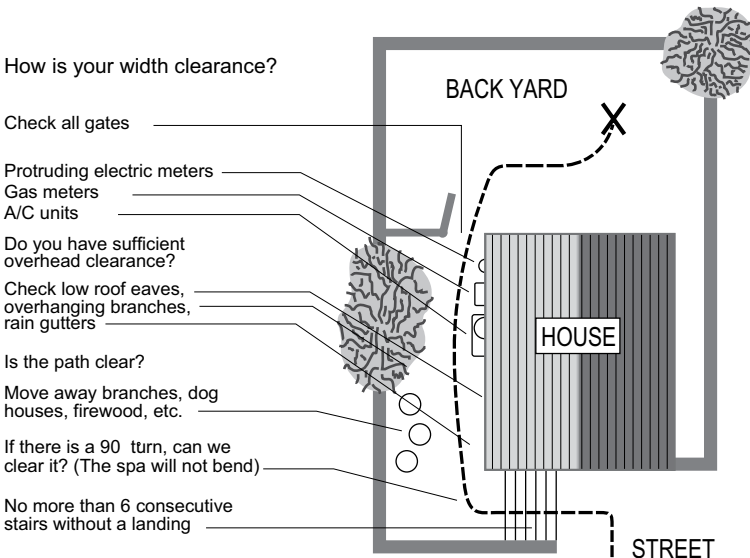

GROUND PREPARATION

Your Hot Spring spa has been engineered to perform on several kinds of surfaces. While a concrete slab is best for long-term use*, other foundations are acceptable so long as a level base is prepared prior to delivery.

***NOTE:** Have a reinforced concrete pad at least 4 inches (10cm) thick or a deck that is able to withstand the pounds per square foot listed in the Spa Specification section.

INSTALLATION NOTES:

- Concrete sloped at 1/2 inch per 10 feet (1 cm per 3 m) is preferred so that rain water and water spillover will run off and not puddle underneath the spa (water under the spa for long periods of time may cause the wood to deteriorate).
- If brick or wood decking is selected for the spa foundation, it should be placed and leveled below the entire spa to maintain even distribution of the spa weight.
- It is important to note that if bricks are used to distribute the weight of the spa there may still be a tendency to settle unevenly, resulting in an unlevel spa.
- Remember, placing the spa around grass or dirt may increase the amount of debris which is inadvertently brought into the spa water on the user's feet.

If you are purchasing a deck package or a gazebo with your spa, a solid foundation becomes mandatory. Placing them on any surface other than a single level pad could create problems with their installation. Pictured at right are a few of the recommended surfaces.

As a homeowner, it is your responsibility to provide a suitable, level foundation for your spa. Keep in mind that most delivery crews are not equipped to level and prepare spa sites.

If you are interested in having a concrete slab, brick surface, or wood deck installed, your Hot Spring dealer should be able to suggest a qualified, licensed contractor.

NOTE: In order for the spa to operate properly and the internal plumbing to drain completely, you must ensure that the spa surface is level before installation. Shimming or point leveling is NOT supported or recommended by the manufacturer.

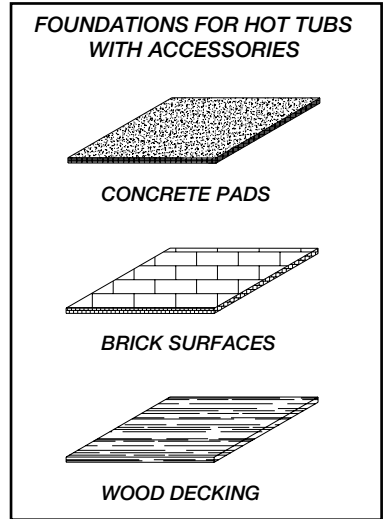

PRISM™ (Model PSM)

Dimensions

NOTE: All dimensions are approximate; measure your spa before making critical design or pathway decisions
Configuration and location may change without notice.

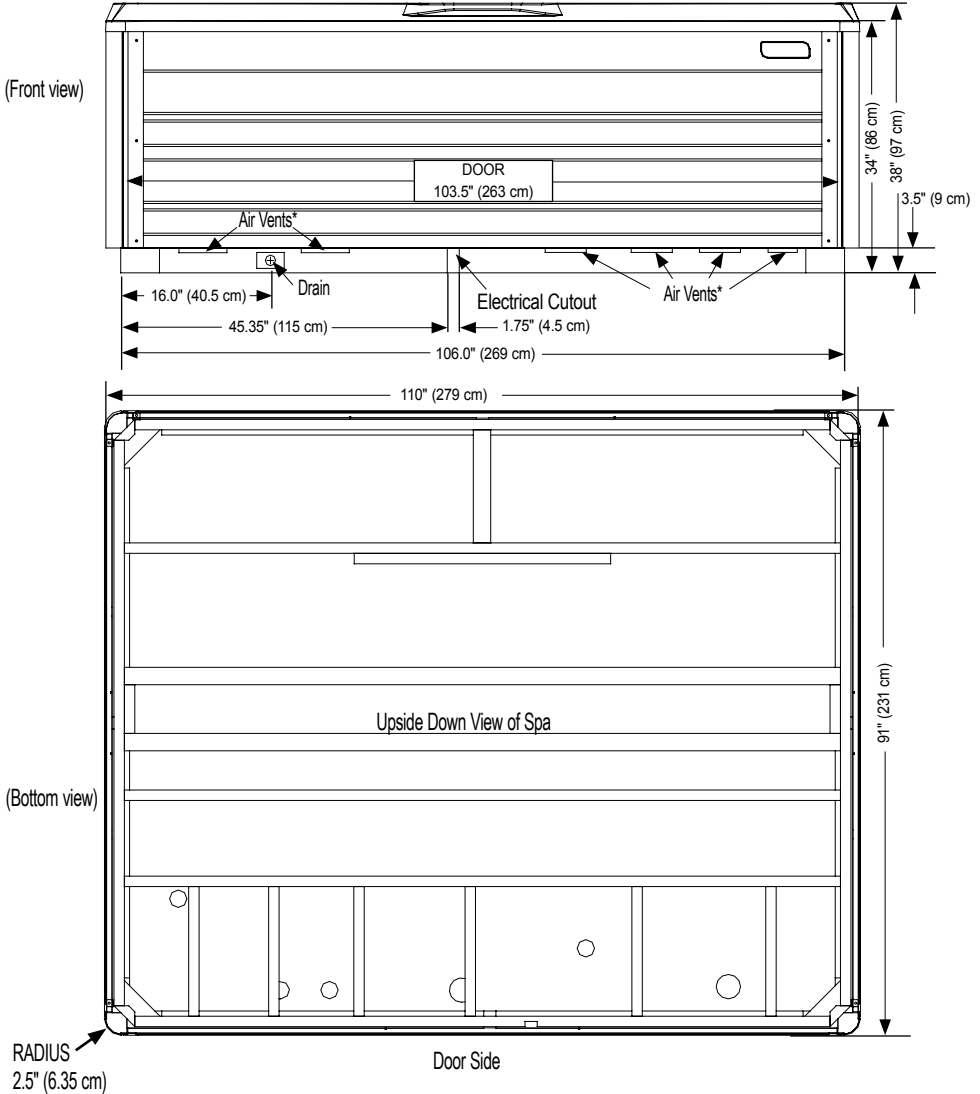

NOTE: WATKINS WELLNESS recommends that the **PRISM** be installed on a minimum 4" (10 cm) thick reinforced concrete pad or structurally sound deck able to support the "dead weight" found in the spa specification chart.

WARNING: The PRISM must not be shimmed in any manner.

***Do not block Air Vents**

PULSE® (Model PLS)

Dimensions

NOTE: All dimensions are approximate; measure your spa before making critical design or pathway decisions.

Configuration and location may change without notice.

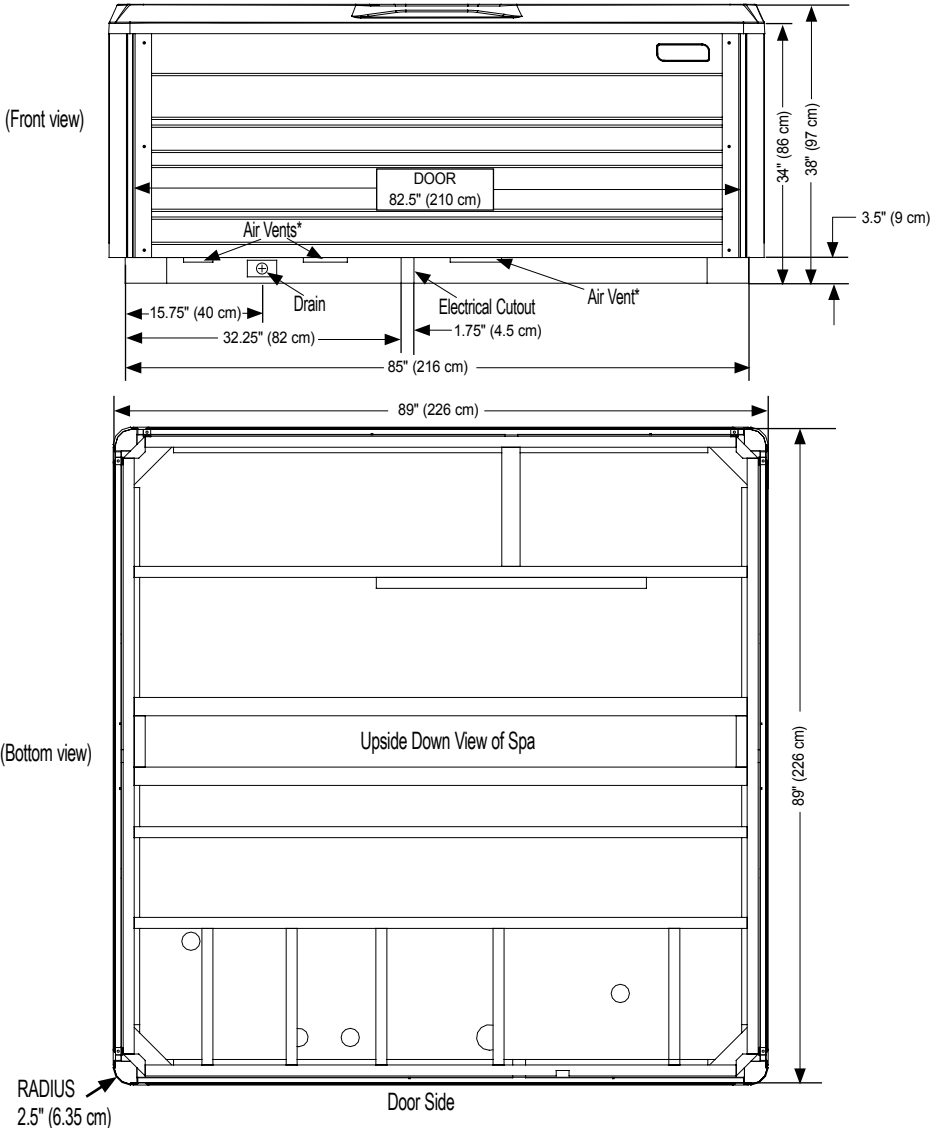

NOTE: WATKINS WELLNESS recommends that the **PULSE** be installed on a minimum 4" (10 cm) thick reinforced concrete pad or structurally sound deck able to support the "dead weight" found in the spa specification chart.

WARNING: The PULSE must not be shimmed in any manner.

***Do not block Air Vents**

FLAIR® (Model FLR)

Dimensions

NOTE: All dimensions are approximate; measure your spa before making critical design or pathway decisions.

Configuration and location may change without notice.

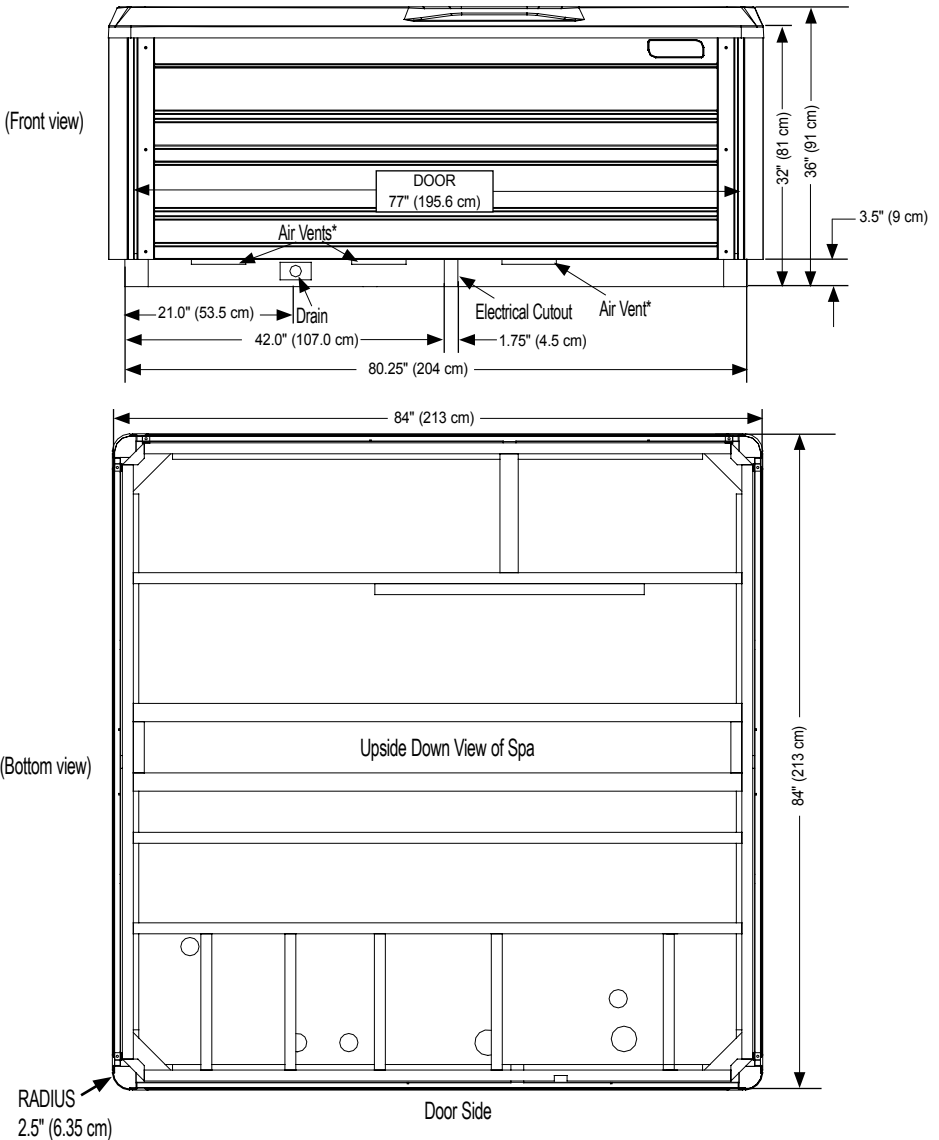

NOTE: WATKINS WELLNESS recommends that the **FLAIR** be installed on a minimum 4" (10 cm) thick reinforced concrete pad or structurally sound deck able to support the "dead weight" found in the spa specification chart.

WARNING: The FLAIR must not be shimmed in any manner.

***Do not block Air Vents**

FLASH™ (Model FSH)

Dimensions

NOTE: All dimensions are approximate; measure your spa before making critical design or pathway decisions.

Configuration and location may change without notice.

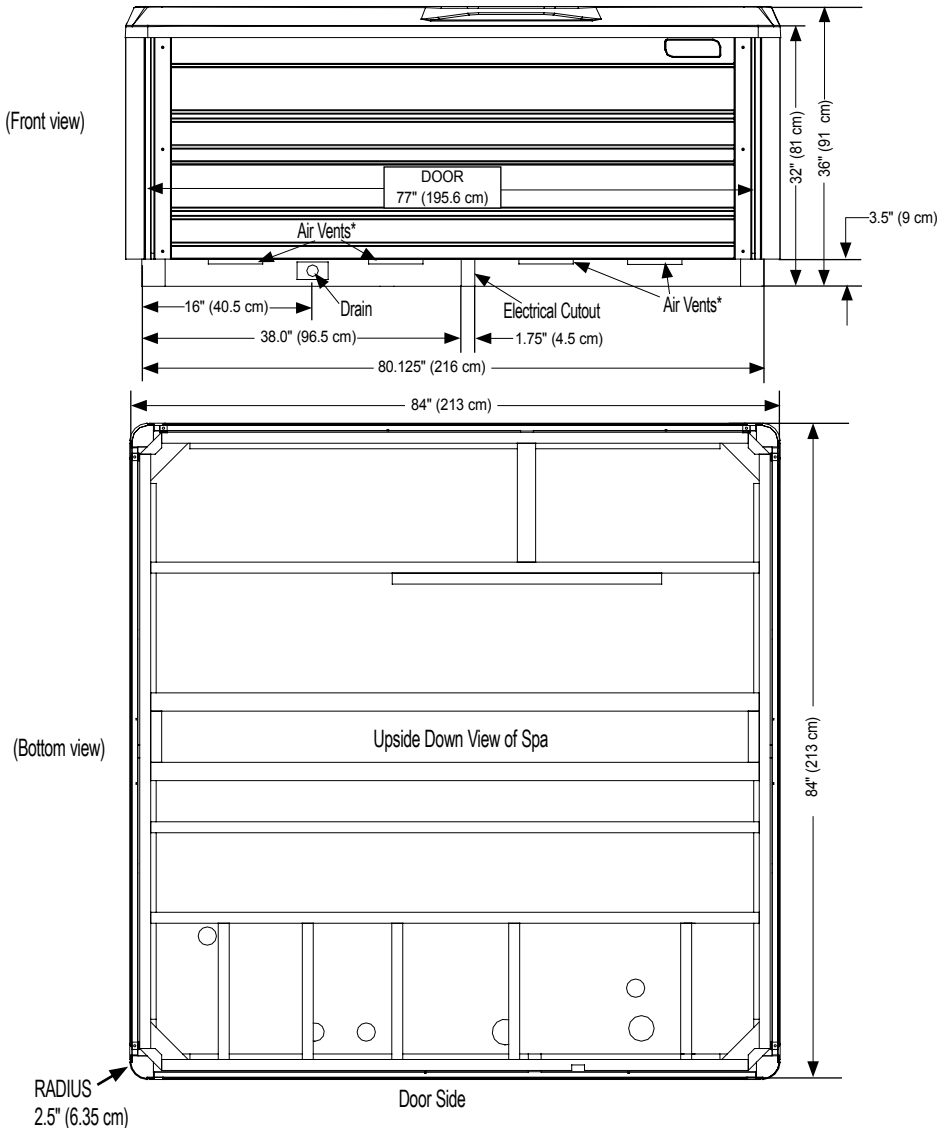

NOTE: WATKINS WELLNESS recommends that the **FLASH** be installed on a minimum 4" (10 cm) thick reinforced concrete pad or structurally sound deck able to support the "dead weight" found in the spa specification chart.

WARNING: The FLASH must not be shimmed in any manner.

***Do not block Air Vents**

BEAM™ (Model BMI & BMII)

Dimensions

NOTE: All dimensions are approximate; measure your spa before making critical design or pathway decisions.

Configuration and location may change without notice.

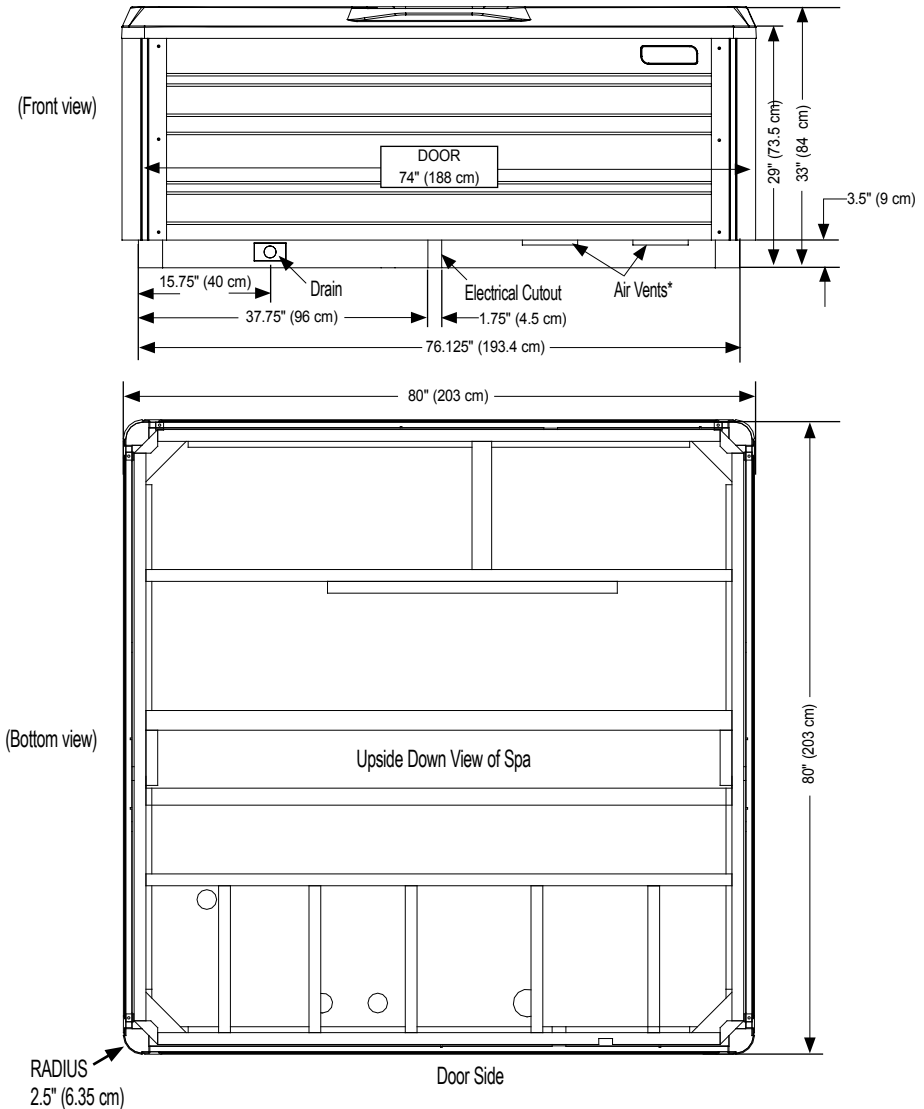

NOTE: WATKINS WELLNESS recommends that the **BEAM** be installed on a minimum 4" (10 cm) thick reinforced concrete pad or structurally sound deck able to support the "dead weight" found in the spa specification chart.

WARNING: The BEAM must not be shimmed in any manner.

***Do not block Air Vents**

ELECTRICAL REQUIREMENTS

To ensure you will have an opportunity to use your spa soon after delivery, it is very important that the required electrical service has been installed. Unless otherwise stipulated by your dealer, THIS IS YOUR RESPONSIBILITY.

IMPORTANT: All electrical circuits must be installed by a qualified, licensed electrician.

230 VOLT OPERATION REQUIREMENTS

230 volt models require a 50 or 70 amp, single phase, 230 volt circuit breaker in the main electrical service panel.

All 230 volt Hot Spring® spas must be wired in accordance with applicable local and national electrical codes, all electrical work must be done by a licensed electrician.

NOTE: WATKINS WELLNESS REQUIRES THE USE OF A SUBPANEL TO SUPPLY POWER AND PROTECT THE SPA. On the **PRISM, PULSE, FLAIR, FLASH** and **BEAM** 230 V models, the 50 amp subpanel containing GFCI breakers is included with the spa. On the converted 230 volt **PRISM** model, a 20 amp GFCI breakers must be purchased separately and can be purchased from your Hot Spring dealer.

A licensed electrician should install a four-wire electrical service (two line voltages, one neutral, one ground) from the main electrical service panel to the subpanel, and from the sub-panel to the spa per the appropriate wiring diagram as illustrated below.

The grounding conductor must be at least #10 AWG. Your electrician should mount the subpanel in the vicinity of the spa but it should not be closer than 5 feet (1.5 m) the spa water edge (NEC 680-38 to 41-A-3).

INSTALLATION NOTE: After the spa has been installed by the dealer's delivery crew, your electrician can connect the conduit from the subpanel to the spa's IQ 2020® Control Box and then complete the wiring connections in the control box.

IMPORTANT NOTE: Three different wiring diagrams are shown: one **PRISM, PULSE, FLAIR** and **FLASH** models 50 amp, one for a **BEAM** BMII 50 amp model, and one **PRISM** 70 amp. Always follow the wiring diagram for your specific model.

NOTE: Complete step-by-step Installation and Wiring Instructions for all 230 volt Hot Spring models are included in the Owner's Manual and with each sub-panel, which can be obtained from your dealer.

WIRE SPECIFICATION NOTE: Long electrical runs may require a larger gauge feed wire than stated. We recommend that a maximum voltage drop of 3% be used when calculating the larger wire size.

Refer to the Wiring Diagrams below for the electrical requirements of the 230 volt Pluse, Flair and Glow models.

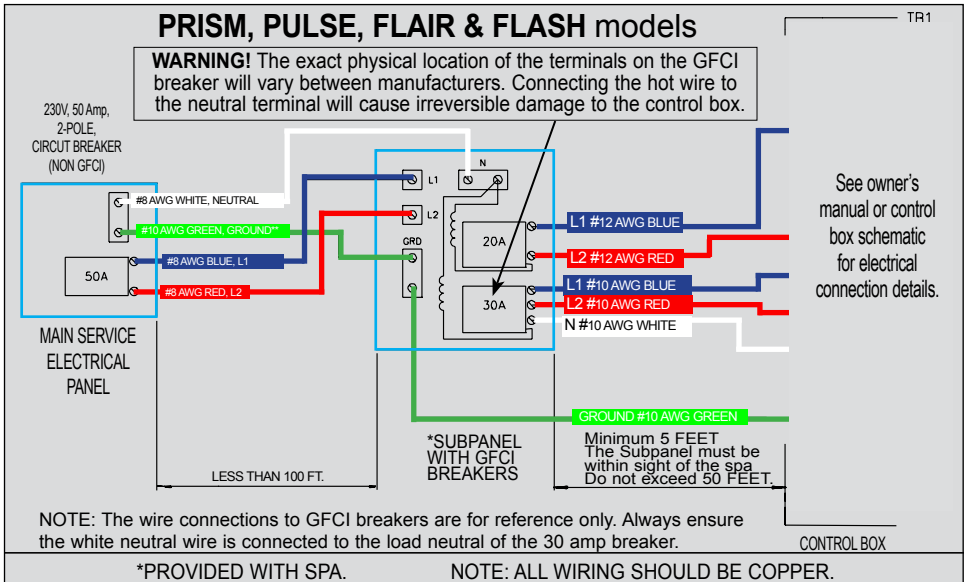

BEAM (model BMII)

230 volt permanently connected loads

WARNING!
The exact physical location of the terminals on the GFCI breaker will vary between manufacturers. Connecting the hot wire to the neutral terminal will cause irreversible damage to the control box.

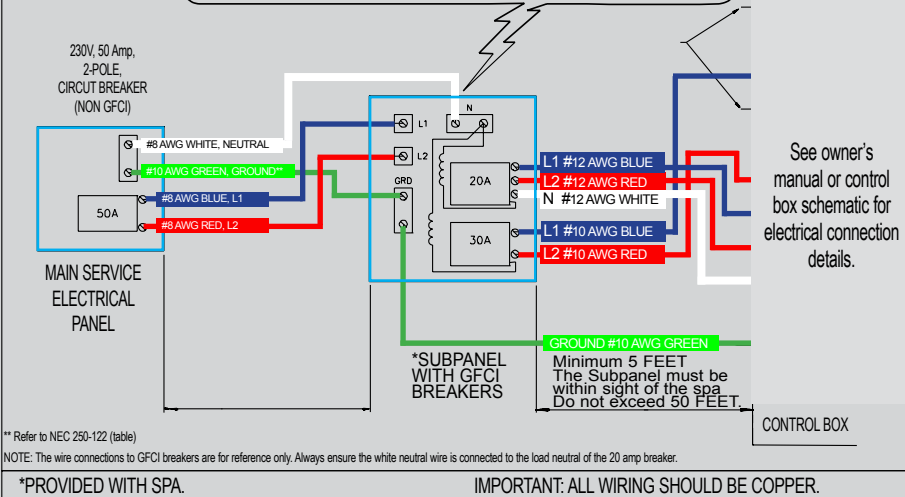

PRISM (CONVERTED-OPTIONAL)

IMPORTANT: If you ever need to move or relocate your Hot Spring spa, it is essential that you understand and apply these installation requirements. Your Hot Spring spa has been carefully engineered to provide maximum safety against electric shock. Remember, connecting the spa to an improperly wired circuit will negate many of its safety features.

IMPORTANT: Service Technician must reconfigure spa using the soft jumpers to allow spa heater to run concurrent with jet pump.

NOTE: Long wiring runs may require larger-gauge wire than stated.

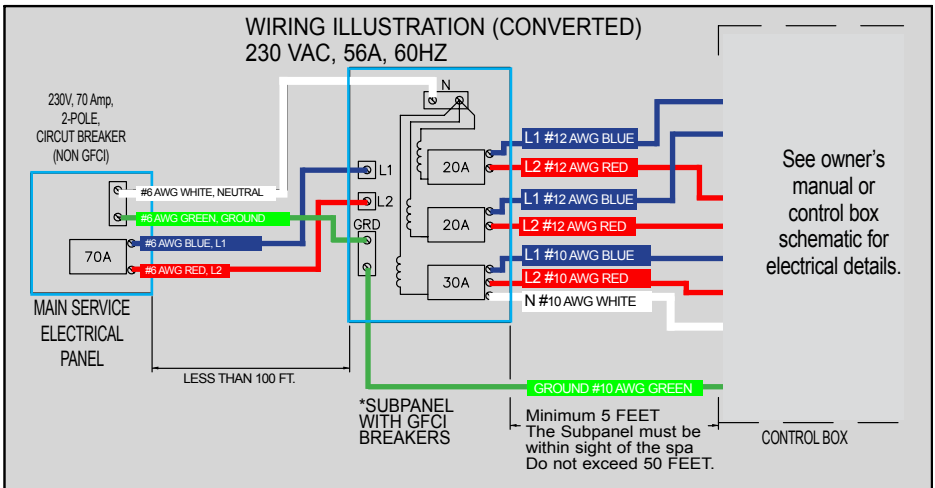

115 VOLT BEAM (MODEL BMI)

115 VOLT GFCI

The Ground Fault Circuit Interrupter (GFCI) is a safety device that is designed to detect as little as 5 milliamps ($\pm 1\text{mA}$) of electrical current leakage to ground. **WATKINS WELLNESS** recommends that the GFCI be tested prior to each use to ensure it is functioning correctly. With the spa connected to the power supply, push the "Test" button. The spa should stop operating and the GFCI power indicator will go out.

Wait 30 seconds and then reset the GFCI by pushing the Reset button. The GFCI power indicator will turn on, restoring power to the spa. If the interrupter does not perform in this manner, it is an indication of an electrical malfunction and the possibility of an electric shock. Disconnect the plug from the receptacle until the fault has been identified and corrected.

IMPORTANT: Failure to wait 30 seconds before resetting the GFCI may cause the spa's Power indicator (on the control panel) to blink. If this occurs, repeat the GFCI test procedure. Never use the GFCI as a means to disconnect power to the spa (always unplug it). If the GFCI is tripped while the spa is plugged in, and a power outage occurs, when power returns the GFCI will automatically reset and power will flow to the spa.

115 VOLT OPERATION (60Hz ONLY)

The spa must be connected to a dedicated 115 volt, 20 amp, GFCI protected, grounded circuit. The term "dedicated" means the electrical circuit is not being used or shared for any other electrical items (patio lights, appliances, garage circuits, etc.). If the spa is connected to a non-dedicated circuit, overloading will result in "nuisance tripping" at the main panel. This requires frequent resetting of the breaker switch at the house electrical breaker panel and introduces the possibility of damage or failure of spa equipment. The dedicated circuit must be properly wired; that is, it must have a 20-amp GFCI circuit breaker in the house breaker panel, #12 AWG or larger wire (including the ground wire) and the correct polarity throughout the circuit.

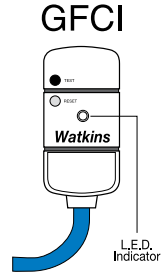

NEVER CONNECT THE SPA TO AN EXTENSION CORD!

A pressure wire connector is provided on the exterior surface of the control box, inside the spa. This is to permit the connection of a ground bonding wire between this point and any metal equipment, enclosures, reinforced concrete pad, pipe, or conduit within 5 feet (1.5 m) of the spa (if needed to comply with local building code requirements). The bonding wire must be at least a #10-AWG solid copper wire.

Bond the spa to all exposed metal equipment or fixtures, handrails, and concrete pad per N.E.C. Article 680 and all local codes.

INSTALLATION INSTRUCTIONS

The 115 volt **BEAM** spa model comes equipped with approximately 15 feet of usable power cord (this is the maximum length allowed by Underwriters Laboratory and the National Electric Code). When the spa is installed, the power cord will come out of the bottom of the equipment compartment door. For your safety, when the electrician is installing the 20 amp single electrical outlet and waterproof cover, the outlet should be no closer than 6 feet (1.8 m) and no farther than 10 feet (3 m) from the spa [reference National Electrical Code].

The Ground Fault Circuit Interrupter (GFCI) is located at the end of the power cord. This device is for your protection. It is very important to protect it from rain and other moisture. Test once a month, with the plug connected to the power supply,

1. Push the "TEST" button on the GFCI breaker. The spa should stop operating and the GFCI power indicator will go out.
2. Wait 30 seconds, then push the "RESET" button. Power will be restored to the spa and the GFCI power indicator will turn on.

If the GFCI fails to operate in this manner, your spa may have an electrical malfunction, and you may be risking electrical shock. Turn off all circuits and do not use the spa until the problem has been corrected by an authorized service agent.

MINIMUM DISTANCE AFTER SPA INSTALLATION 6'

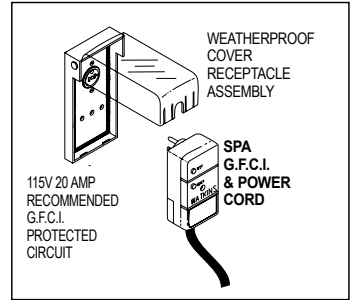
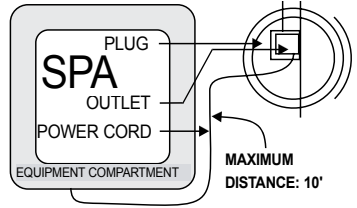

⚠ WARNING: Removal of the GFCI from the spa's power cord will result in an unsafe spa and will void the spa's warranty.

IMPORTANT: Should you ever find the need to move or relocate your Hot Spring spa, it is essential that you understand and apply these installation requirements. Your Hot Spring spa has been carefully engineered to provide maximum safety against electric shock. Remember, connecting the spa to an improperly wired circuit will negate many of its safety features.

ADVANTAGE TO HAVING YOUR SPA CONVERTED

- In the 115 volt configuration, either the heater, or the jet pump can operate, but they can't work at the same time. In a 115 volt system, as long as the jet pump is activated, the heater will not turn on. On the other hand, when the spa is converted to operate in the 230 volt configuration, the heater and jet pump can operate simultaneously.
- The heater will operate at 1500 watts when the spa is configured as a 115 volt cord-and-plug connected model, and at 6000 watts when the spa is configured as a 230 volt converted model heating your spa water faster.

115/230 VOLT CONVERTIBLE MODEL

The **BEAM** (model BMI) can be converted to 230 volt operation with the addition of a subpanel and a control box wiring change. Consult your dealer before attempting to convert from 115 volt operation to 230 volt operation. Any damage to the spa from improper conversion is not covered under the warranty.

230 VOLT CONVERTED BEAM (MODEL BMI)

HOT SPRING spas must be wired in accordance with all applicable local electrical codes. All electrical work should be done by an experienced, licensed electrician. We recommend the use of appropriate electrical conduit, fittings, and wire for all circuits.

Refer to the following instructions to convert from 115 volt to 230 volt

IMPORTANT: Converting the spa to 230 volt operation will require both an authorized **HOT SPRING** service agent and a qualified electrician.

Required Part: A Subpanel (230 volt Convertible) available from your **HOT SPRING** dealer.

1. Disconnect the power cord from the house receptacle.
2. Open the equipment compartment door.
3. Remove the screws on the front of the spa control box.
4. Open the control box cover.
5. Identify Terminal block located in the lower left-hand corner inside the control box.
6. Refer to illustration, Step 1. Remove the 2 pin jumper attached to terminals 4 and 5.
7. Refer to illustration, Step 1. Remove the wire jumper from terminals 2, and 6.
8. Refer to illustration, Step 2. Remove the power cord wires from 5, 7 and GRD (not illustrated).
9. Unscrew the power cord strain relief and remove the power cord from the access hole in the control box.

⚠ **WARNING:** Do not allow pliers to contact any electronic components inside the control box.

Converting from 115 volts to 230 volts changes the voltage supplied to the heater from 115-volts to 230 volts. The jet pump will continue to operate at 115 volts.

Have your licensed electrician wire subpanel from a 50A Main Service, then from subpanel into the spa's control box using the following illustration or use the wire diagram on the inside of the control box lid.

IMPORTANT: The subpanel must be placed in sight of the spa, at a minimum distance of 5 feet (1.5 m) away.

WIRING CONNECTIONS

IMPORTANT: Fill the spa with water before turning on the power

Once your spa has been filled with water, turn it on and test all the circuit breakers.

Each breaker should be tested prior to each use. Here's how:

1. Push the "TEST" button on each GFCI breaker, and observe it click off.
2. Wait 30 seconds, then push the breaker switch to the OFF (down) position (to ensure that it has completely disengaged), then push the breaker switch to the ON (up) position. If you don't wait 30 seconds, the spa's power indicator may continue to blink – try again.

If any of the GFCI breakers fails to operate in this manner, your spa may have an electrical malfunction, and you may be risking electrical shock. Turn off all circuits and do not use the spa until the problem has been corrected by an authorized service agent.

IMPORTANT: Service Technician must reconfigure spa using the soft jumpers to allow spa heater to run concurrent with jet pump.

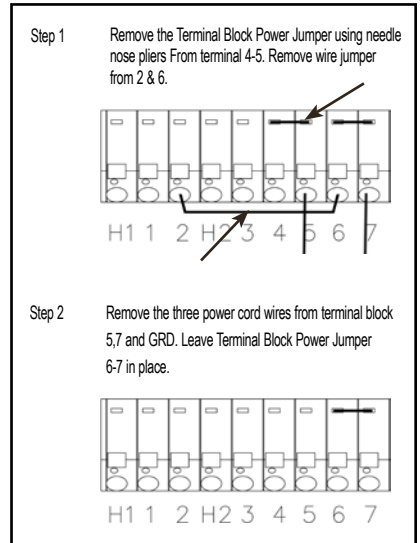

BEAM (Model BMI)

230 volt converted mode

WARNING! The exact physical location of the terminals on the GFCI breaker will vary between manufacturers. Connecting the hot wire to the neutral terminal will cause irreversible damage to the control box.

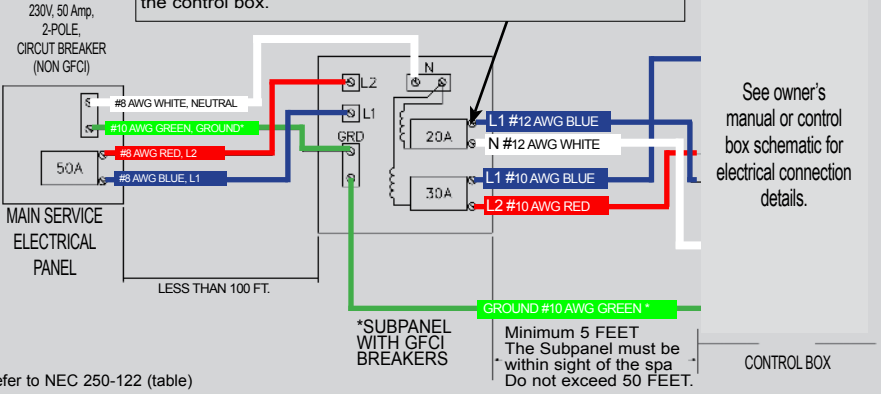

* Refer to NEC 250-122 (table)

NOTE: The wire connections to GFCI breakers are for reference only. Always ensure the white neutral wire is connected to the load neutral of the 20 amp breaker.

AVAILABLE FROM DEALER.

NOTE: ALL WIRING SHOULD BE COPPER.

CONTRACTOR SUGGESTIONS

Electrician

Name: _____

Telephone: _____

Name: _____

Telephone: _____

Masonry

Name: _____

Telephone: _____

Name: _____

Telephone: _____

General

Name: _____

Telephone: _____

Name: _____

Telephone: _____

SERVICES AVAILABLE FROM YOUR HOT SPRING® DEALER

Service

Cost

Pre-Delivery site inspection _____

Deliver spa to installation site _____

Unwrap spa and haul away packaging material _____

Set up _____

Install FreshWater® Salt System _____

Fill the spa with water _____

Explain and test the spa's operation _____

- Jet system
- Air Control system
- Set temperature control
- Control panel functions

Explain the safety features

- GFCI
- Heater high limit
- Heater thermal cut-off

Service

Cost

General spa operation & maintenance orientation

Water quality and maintenance orientation

Adjust the water's Total Alkalinity, and pH

Sanitize the water

Inspect the spa cover, place on spa

Review winterizing instructions

Review Owner's Manual & Register your Warranty

Follow-up call

In-store spa water analysis

TOTAL COST

ADDITIONAL PRODUCTS AVAILABLE FROM YOUR HOT SPRING® DEALER

- FreshWater® Salt System
- FreshWater® Smart Monitoring System
- FreshWater® Salt System Replacement Cartridges
- FreshWater® Spa Salt
- FreshWater® Salt Test Strips
- FreshWater® 5-way Test Strips
- FreshWater® III high output ozone, MPS and FreshWater® Ag+ Silver Ion Cartridge (sold separately)
- Clean Screen® Pre-filter
- Vanishing Act® Calcium Remover
- FreshWater® Bottled Water Care Products
- FreshWater® Instant Filter Cleaner and Filter Cleaner
- FreshWater® Cover Shield
- Retractable cover systems including the CoverCradle®, CoverCradle II, UpRite and Lift'n Glide® systems.
 - Cover Cradle - 24" (61 cm) Clearance required
 - Cover Cradle II - 24" (61 cm) Clearance required
 - UpRite - 7" (18 cm) Clearance required
 - Lift 'n Glide - 14" (36 cm) Clearance required
- Polyester covers
- Spa steps
- Replacement filter cartridges
- Pillows

<p>NOTE: Actual clearance may vary depending on spa model and installation location. Check with dealer for further details.</p>

Spa Specifications

	Footprint dimensions	Height	Effective filter area	Heater (Watts)	Water capacity	Dry weight	Filled weight*	Dead weight*	Electrical requirements
PRISM (Model PSM) Seats 7 Adults	9' 2" x 7' 7" 2.79m x 2.31m	38" 97cm	150 ft ²	4,000	525 gallons 1,990 liters	1,190 lbs 540 kg	6,795 lbs 3,085 kg	120 lbs/ft ² 585 kg/m ²	230 volt, 20A & 30A or 20A, 20A, & 30A Single phase GFCI protected circuits
PULSE (Model PLS) Seats 7 Adults	7'5" x 7'5" 2.26m x 2.26m	38" 97cm	100 ft ²	4,000	445 gallons 1,685 liters	1,015 lbs 460 kg	5,950 lbs 2,700 kg	130 lbs/ft ² 635 kg/m ²	230 volt, 20A & 30A Single phase GFCI protected circuits
FLAIR (Model FLR) Seats 6 Adults	7'0" x 7'0" 2.13m x 2.13m	36" 91cm	100 ft ²	4,000	335 gallons 1,270 liters	875 lbs 400 kg	4,720 lbs 2,140 kg	120 lbs/ft ² 585 kg/m ²	230 volt, 20A & 30A Single phase GFCI protected circuits
FLASH (Model FSH) Seats 7 Adults	7'0" x 7'0" 2.13m x 2.13m	36" 91cm	100 ft ²	4,000	360 gallons 1,365 liters	845 lbs 385 kg	5,070 lbs 2,300 kg	125 lbs/ft ² 610 kg/m ²	230 volt, 20A & 30A Single phase GFCI protected circuits
BEAM (Model BMI) Seats 4 Adults	6'8" x 6'8" 2.03m x 2.03m	33" 84cm	100 ft ²	6,000	295 gallons 1,115 liters	700 lbs 320 kg	3,860 lbs 1,750 kg	110 lbs/ft ² 540 kg/m ²	230 volt, 20A & 30A Single phase GFCI protected circuits
BEAM (Model BMI) Seats 4 Adults	6'8" x 6'8" 2.03m x 2.03m	33" 84cm	100 ft ²	1,500 or 6,000	295 gallons 1,115 liters	700 lbs 320 kg	3,860 lbs 1,750 kg	110 lbs/ft ² 540 kg/m ²	115 volt, 20 amp dedicated GFCI OR 230 volt, 20A & 30A Single phase GFCI protected circuit

CAUTION: Watkins Wellness suggests a structural engineer or contractor be consulted before the spa is placed on an elevated deck.

* **NOTE:** The "Filled weight" and "Dead weight" of the spa includes the weight of the occupants (assuming an average occupant weight of 175 lbs [80 kg]).



WatkinsWellness®

Feel good. Live well.

1280 Park Center Drive

Vista, California 92081

(800) 999-4688 extension 8432

©2024 WATKINS WELLNESS. Limelight, Hot Spring, Prism, Pulse, Flair, Flash, Beam, IQ 2020, CoverCradle, UpRite, Vanishing Act, Clean Screen, Lift'n Glide, FreshWater, and The Home Relaxation Specialists are trademarks of WATKINS WELLNESS.

62905.25A (10/24)